

+1,035

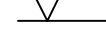

±0,00

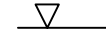

-1,480

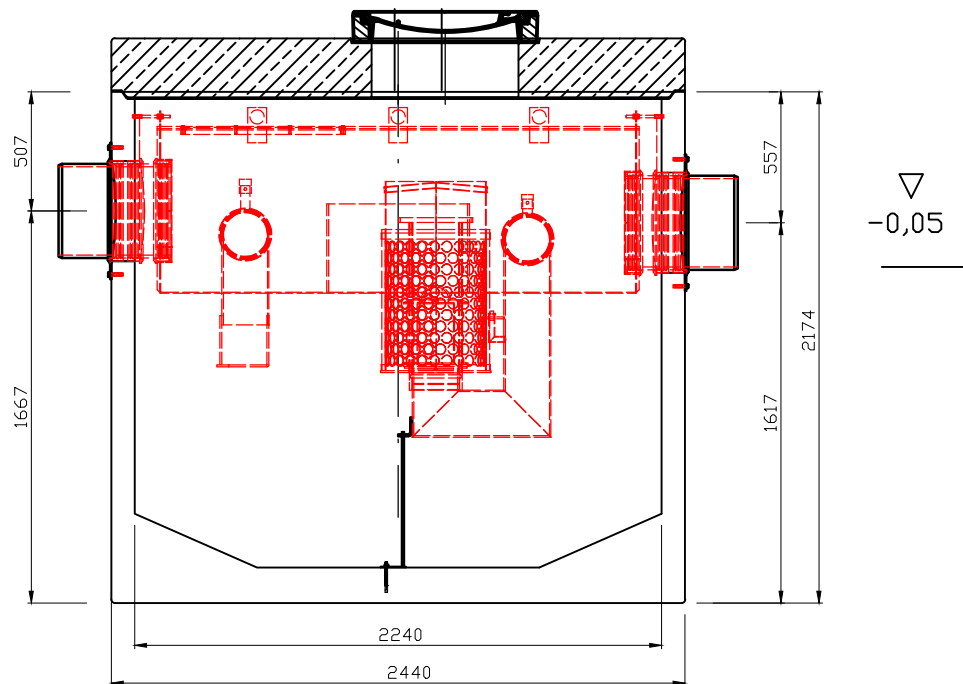
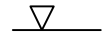

WLOT  
DN 400

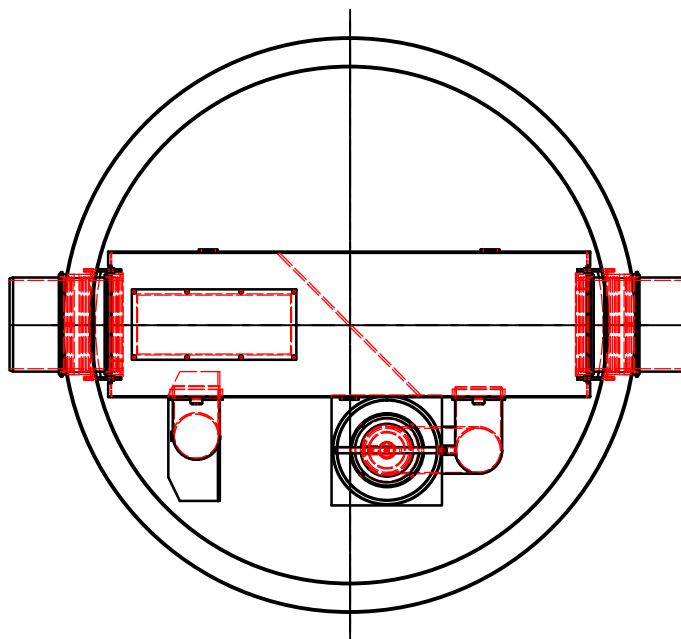
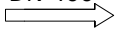

WYLOT  
DN 400

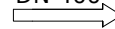

TYP URZĄDZENIA

15/150/3000

Numer katalogowy

741.570AS

Skala

-

wersja standard

Rodzaj urządzenia

OLEOPASS



ACO Elementy Budowlane Sp. z o. o.  
Łajski, ul. Fabryczna 5 Tel.: 0-48 22 76 70 500  
05-119 Legionowo Fax: 0-48 22 76 70 513

Producent zastrzega sobie możliwość wprowadzenia zmian technicznych.

Stan na maj 2014

Opracował: mgr inż. Jarosław Maślany