

Joints

Construction and sealing of joints according to valid standards and regulations. Therefore an appropriate joint plan has to be provided by the planner.

Expansion joints may not be installed directly to the channel, because the channel cannot take the loadings from thermal caused concrete expansion.

Longitudinal expansion joints are recommended to be positioned according to the appropriate ACO Drain installation advice.

If transversal joints cross the channels bed and haunch, such joints may be positioned to coincide with the channel-to-channel joint, or the channel may be cut to suit and re-sealed with suitable flexible sealant.

At afterwards installation of channels in concrete or pavement in concrete bedding the planner has to make sure, that enough expansion joints will be installed. The joints have to ensure,

that thermal expansions from the concrete slab won't harm the channel.

In an unreinforced concrete haunch please position a concrete joint every 1-2 m. Alternatively the haunch could be constructed reinforced.

Longitudinal expansion joints may be doweled if necessary.

At use of mastic asphalt we recommend filling the joint in two phases. First fill grouting mortar up to 1,5 cm under surface level and second fill remaining space with bituminous water stop.

The final location, width and geometry of expansion joints have to be determined by the planner or structural engineer.

Sealing

According to EN 1433 the body of drainage channels has to be watertight and the design has to provide a possibility of sealing the channel joints.

With the patented safety joint ACO provides a well-fitting channel joint which can be sealed to get a watertight channel up to the top of the edge rail, if required.

The preinstalled lip labyrinth sealing makes a watertight connection of vertical pipes possible.

For an elastic sealing we recommend to use EUROLASTIC TC 30S as sealant in conjunction with EUROLASTIC Primer S2, or similar, depending on what's available on your market. Please contact your local supplier to get more information about appropriate products.

1. Seek the sealant manufacturer's advice on suitability on all occasions.
2. For filling the sealant into the groove please use the sealing set (art.no. 01376) consisting of a cartridge gun, a cartridge, a stirrer and some tips in different sizes.
3. Storage of the sealant has to be frost free.
4. Use of the sealant at minimum 5°C (41°F) air temperature and surface temperature of 5 – 35°C (41-95°F).
At 20°C (68°F) the curing time is 24 hours.
5. Attention: Polymer concrete surfaces have to be cleaned carefully.
6. After cleaning put on primer EUROLASTIC Primer S2 (art.no. 10682) by using a paintbrush and let it flash off for approx. 30 minutes.
7. Put the cartridge with the 2 component sealant into the cartridge holder and stir it by using the stirrer with a drilling machine. Mix the sealant at least 3 minutes with 400 turns per minute until the colour is unique.
8. Before setting cartridge into the cartridge gun, please remove the plastic cap, which is only needed for the use of sealant in bags.
9. Always make sure, that the sealant is connected to the sealing at the channel edge to ensure a complete sealed system.
10. Smooth the surface by using a spatula which is dipped in soap solution.
11. Cleaning of equipment with acetone or Eurolastic G.
12. Technical data and safety sheets are available at www.euroteam-bauchemie.de or at the international support department at ACO headquarter in Büdelsdorf.

ACO polymer concrete and the sealant are resistant against a wide range of mediums. For information about all not listed mediums, please contact the ACO International Support Department.

If Multiline Seal in or Monoblock RD200V is used, a sealing of joints is not necessary, because these systems have an integrated sealing.

Channel systems made of plastic require an additional effort if joints have to be sealed. XtraDrain and Hexaline are made of Polypropylene and have to be welded to get watertight joints.

Special installation advices

All shown installation details are exemplary advices and represent the whole channel system. Even the illustration of paving and asphalt layer is representative and has to be adjusted to the planner's advice and all valid local regulations and standards.

According EN 1433 ACO channels may have tolerances in height, length and width of ± 2 mm. Additional tolerances during installation are possible and have to be considered.

Depending on the circumstances and the local requirements drainage channels always need a foundation (Type M) like shown in our ACO DRAIN® installation advice.

Where a channel drain is being inserted within an existing slab, in a box-out cut or cast within a slab, a minimum 25 mm clearance around the channel is required for grouting. The channel may be suspended in the box-out while being grouted. Bed and haunch the channel with a proprietary epoxy-mortar grout with a minimum strength of 30N/mm²; advice should be sought from the grout manufacturer.

If a channel crosses an expansion joint in an existing concrete slab, the channel should be sawn in half where it crosses the joint, and re-joined with a proprietary flexible sealant.

Shallow channels are special channels which only differ in height from ordinary channels. Caused by the shallow clear height the hydraulic capacity is limited and should be proved by an ACO application engineer. In general they are used in parking decks, inside buildings or in areas with shallow layers and limited space.

Drainage channels in floors should always be installed upon the waterproofed layer. A direct connection of waterproofed layer and channel is not possible. Sealing of the channel joints is highly recommended.

When intermediate piece DN100 or DN150 with clamping flange is used, the nozzle may not reach longer than 60mm into the intermediate piece to provide a proper runoff of the water.

Drainage channels are always installed on same level like the adjusting area. In asphalt or paved areas the channel top shall be installed app. 5mm under the surrounding surface. In concrete areas a levelled installation is possible.

In areas with more than 5 % slope we recommend to choose one load class higher than needed to make sure, that thrust and other loadings are distributed properly.

At extreme loadings within load class D400 – F900 you should differ between occasionally and constantly traffic.

Even traffic crossing the channel, narrow corners, slow moving traffic, often braking and accelerating could mean to install after a special installation advice.

In case of extreme loadings we recommend to install according one load class higher than needed.

Extreme loadings could be container terminals, loading zones, logistic areas or sloped areas.

For these application we advise to choose ACO DRAIN® PowerDrain or ACO DRAIN Monoblock system.

In front of rail way crossings we recommend to use Monoblock in every case.

As well for high dynamic loaded areas like highways we recommend using Monoblock only.

Accessories like sump units and revision units should always be located outside the trafficked area.

Mitre joints are formed by sawing the channels (eg with disc cutter) to the required angle and butting them together dry jointed or resin bonded. A suitable adhesive should be used in a corrosive environment. The sealant used should be able to withstand contact with the effluent or chemical solution.

Where possible, 90° joints and Ts should be formed such that gratings do not have to be cut. 90° channel junctions are available as standard and pre-mitred joints are available to special order, or angles can be formed with connecting proprietary PVC pipework on ACO inlet/outlet endcaps.

Note: For load classes higher than C250, mitred joints are not recommended in trafficked areas and it is recommended that ACO DRAIN® S Range and PowerDrain are not mitred. ACO can custom-manufacture angled junctions to order. Always consider health and safety instructions when cutting.

Special installation advices



Products made from galvanized steel should only be installed in areas where contact to chemical cleaning devices, heavy acids and solutions as well as acetic acid containing silicon is impossible. For special applications please get in contact with an ACO application engineer.

During installation and site work products made from stainless steel should be protected against flying sparks (Disc cutter) and flash rust during installation to prevent a bad looking surface and a dissatisfied customer. We recommend testing the compatibility of stainless steel (1.4301) and other metals to avoid contact corrosion. For applications with contact with sea air, salt water, chemicals or other environmental influences please check if more high-grade stainless steel would be better to use. To keep the good looking smooth surface of stainless steel products and to prevent rusting we recommend to clean all surfaces occasionally with fresh water.

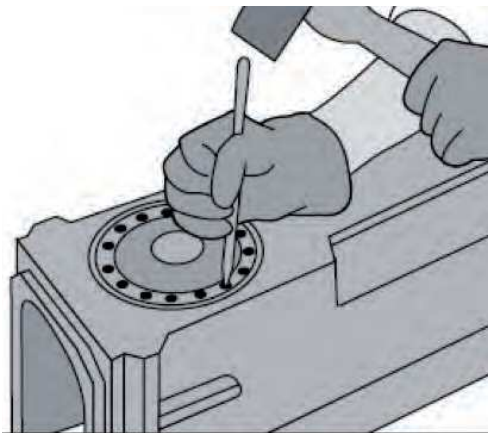

Please cut black rubber walls at sump units not before cleaning the channel and the silt bucket to prevent dirt entering the sewage system before customer has made the approval of the project. For cutting please use a sharp knife and cut along the connected channel.

At Brickslot frames in brick paved areas it might happen, that sand from transversal paving joints trickles into the slot.

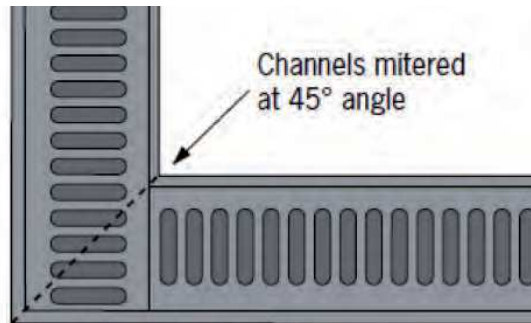

**Channels are mitered;
grates are shown as tee joint.**

Products made from ductile iron are delivered with two different coatings. ACO DRAIN® PowerDrain is coated with a cathodic dip painting, which is quite long lasting dependent on the environmental influences.

All other systems are delivered with a coating which is meant to be a temporary protection for storing, delivery and installation and will be removed after short time to give the grating and edge rail the typical ductile iron look. This is no lack of quality and no reason for a complaint at all.

All preformed knockouts are made to be knocked out from the inside to the outside. To avoid breakage we highly recommend perforating the knockout by drill or chisel before knocking out.

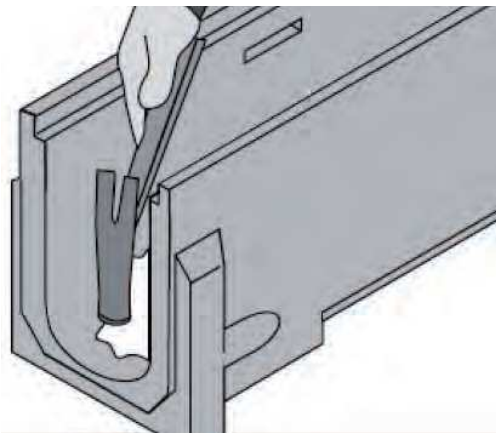

At Brickslot frames in asphalt areas we recommend installing a row of bricks adjoining the slot frame to make the installation of the asphalt easier. Even a possible renewing of the surface is much easier if the cold planer can use the row of bricks as a fence.

To protect the environment we recommend sealing joints in areas where will be handled with hazardous liquids and

and mediums. Before sealing please make sure that all materials and mediums are compatible to each other. If you have doubts, please contact ACO International Support Department to get the remaining information.

For this kind of applications, it might be necessary to have a closer look for some special regulations in your state or county.

Grouting of joints between kerbs and channel or facades and channel should be made like shown in the appropriate ACO DRAIN® installation advice later on in this guideline. We recommend using a high-strength (but dynamic loadable), non-shrinking and de-icing salt resistant mortar which meets all requirements considering all conditions (loading, resistance etc.) on site. The joints measurements shall be according to the mortar manufacturers advice.

To prevent mortar leaking into the channel we recommend to tighten channel joints from the outside (duct tape) before grouting.

Materials of manufacture

ACO drain channels are manufactured from ACO resin concrete, consisting of polyester resin reinforced by mineral aggregates and fillers or.

The appearance is self-coloured light brown or can be pigmented to match virtually any colour shade, and resin concrete offers high quality, precise detailing.

A channel repair kit comprising polyester paste and hardeners is available for minor repairs or non-flexible channel joints.

Physical properties

Channels

ACO resin concrete is a strong material offering approximately four times the compressive strength of average concrete, and half the weight (for an equivalent channel section).

ACO drain systems are available in types to suit load classes A15 to F900 as specified in EN 1433.

Flexural strength	20 - 25 N/mm ²	
Compressive strength	90 - 100 N/mm ²	
Modulus of elasticity	20 - 25 N/mm ²	
Density	2,1 - 2,3 g/cm ³	
Typical water absorption	0,05 - 0,1 %	(by weight)
Roughness	25 µm	
Fire behaviour	non-flammable	
Water penetration	0,0 mm	

When connecting the pipe to the sump unit, please don't push the pipe against the silt bucket.

To get the optimum outlet capacity the pipe has to be inserted only right through the lip labyrinth sealing.

If foul air traps are used, please consider that water remaining in the sump unit could freeze in winter times and cause distortion of the sump unit.

Sump units shall be installed appropriate to the channel system.

For special demands or custom made products which you won't find in this guideline please feel free to get in contact with the ACO International Technical Support Team, who will help you creating a proper solution for your special application.



Comparison of drainage channel materials

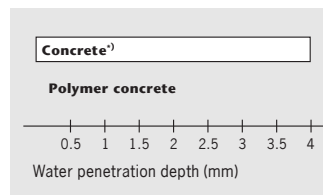

Water penetration depth (DIN 4281) after 72 hours

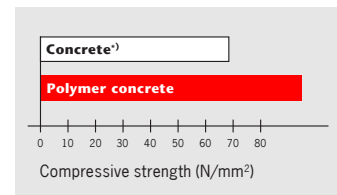

Compressive strengths

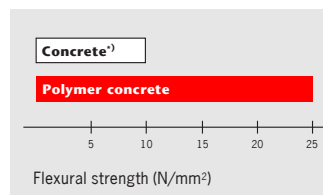

Flexural strengths

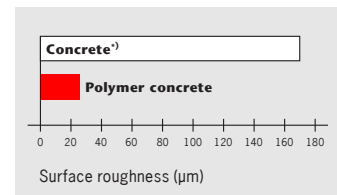

Average surface roughness of drainage channels

¹⁾ Concrete for use according to DIN EN 1433

Surface performance

The ultra-smooth internal surface (Manning Strickler roughness coefficient average value is 0,011) encourages superior liquid flow for a given nominal cross-section when compared to conventional concrete. ACO drain channels allow greater discharge rates to be achieved, or longer lengths of channel to be installed before an outlet from the system is required.

Chemical resistance

Standard polyester resin concrete ACO drain channels are highly resistant to chemical attack and, with the appropriate grating, can be used in most environments where acids and dilute alkalis are likely to be encountered. The material is not affected by road de-icing salts.

In situations where exposure to aggressive chemicals is likely please check resistance of polyester resin concrete. See chart on page 20, which gives the resistance of standard polyester and joint sealant to various common industrial and agricultural chemicals with given concentration at room temperature (23°C).

Reaction to fire

For applications in tunnels it is very important to provide a non-flammable channel unit. Our special mixture of polyester resin concrete fulfils this requirement and is tested according EN 13501-1.

Gratings

Separate gratings are available in galvanised steel, stainless steel, epoxy glass reinforced composite and ductile iron. Special grating materials and non-standard finishes are available on request.

Grating bolts, where provided, are Tuflok coated high-tensile steel or stainless steel with integral friction grip washers. Quicklock and Powerlock are provided as standard locking on some systems.

Resistance to high and low temperatures

With low moisture absorption the channels are completely resistant to frost. The maximum temperature for permanent content is 80°C.

ACO drain channels can be occasionally exposed to boiling water, or steam cleaned, without risk of damage. Where continual exposure to boiling liquids or intensive steam cleaning is likely, an alternative channel material, for example stainless steel, should be considered; contact Inotec Sportanlagen- und Edelstahltechnik GmbH on +49-(0)4331-354-600

Resistance to vandalism

Most ACO drain systems are available with lockable gratings which are sufficient to deter casual vandalism. Where vandalism is likely to be a serious problem, bolted gratings should be specified or alternatively a security locking can be used to prevent vandalism.



ACO DRAIN® Multiline Seal in drainage channel

As a manufacturer of drainage channels, we are obligated in accordance with DIN EN 1433, Point 7.17 and Point 11, to provide generally applicable installation regulations. The specifications in this document only represent an extract of our entire documentation.



Contents

- A** Installation of catch basin

- B** Installation of end caps
 - 1. Installation of universal end cap for male and female end
 - 2. Assembly of end cap with lip labyrinth seal (LLS)

- C** Fabrication of fitting pieces or adapters to change flow direction

- D** Fabrication of corner, T or cross connection

- E** Installation of channel and Installation drawings for plaster, asphalt and concrete

A Installation of catch basin

Before installing the catch basin

Prepare the relevant accessories as described below and fit it on the catch basin.

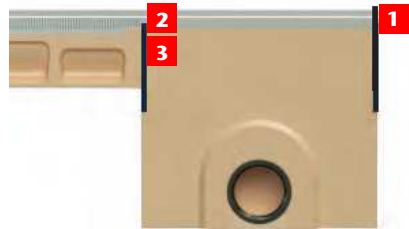

Accessories (included in the scope of supply for the catch basin)



A Installation of catch basin

1 Installing the end cap on the catch basin



Push against the boundary point



Press on



End cap locked into place

If one side of the catch basin is without a connected channel, it has to be closed by using the catch basin end cap (art. no.132384). It is important to ensure that the attached gasket always faces the catch basin.

Push end cap as far as possible towards the upper boundary of the attached cut-out template. When you press these two parts together, you will hear them lock into place.

2 Connecting a channel element, types 0-10, to the catch basin



Shorten using side cutters if necessary



The **short-form** connection adapter (art. no. 132382) is required for connecting the **channel elements, type 0-10**. When connecting **type 0-9**, the connection adapter needs to be shortened using the markings specified on both legs.

We recommend using commercial side cutters for this purpose. Shortening is not required for Type 10.



Push all the way up



Press on



Connection adapter locked into place

When connecting a channel, it is important to ensure that the attached gasket always faces the catch basin, to guarantee a watertight connection.

To install, push the connection adapter legs as far as possible towards the upper boundary of the attached cut-out template. When you press these parts together, you will hear them lock into place.

**Connecting a channel element, type 20,
to the catch basin**

Step 3 only necessary with "long-form" version

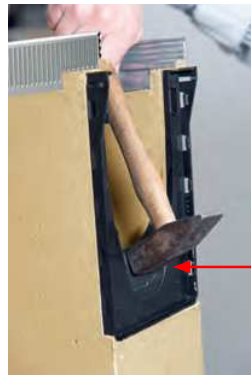

Removed completely

The **long-form** connection adapter (art. no. 132383) is required for connecting a **channel element, type 20**. Prior to connection, the attached cut-out template for the catch basin has to be knocked out by hammer from the outside to the inside.



Press on



Connection adapter locked into place



When connecting a channel, it is important to ensure that the attached gasket always faces the catch basin, To install, push the adapter as far as possible towards the upper boundary of the attached cut-out template. When you push these parts together, you will hear them lock into place.

B Installation of end caps

Installation of universal end cap for male and female end

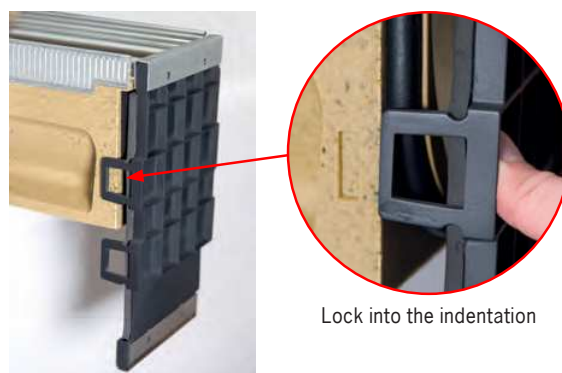
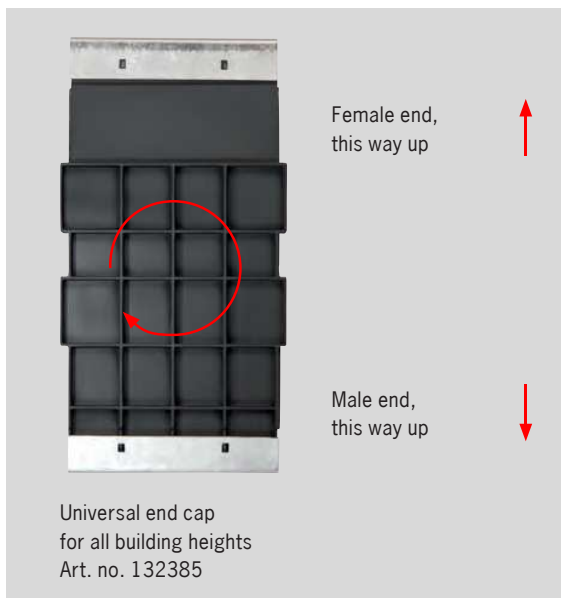

The universal end cap is suitable for the male and female end, all channel heights and every channel type from the ACO DRAIN® Multiline Sealin product range.

On the inlet side, attach the universal closing end cap so that the inscription on the rear is facing up. For the male end (outlet side with integrated seal), the end cap must be rotated 180 degrees. You will also find instructions on how to do this on the universal closing end cap.

The end cap has a side locking mechanism that enables attachment in the indentations provided on the side of the channel. During installation, the locking device always faces the channel and may need to be turned 180 degrees depending on whether you are working at the inlet or outlet side.

If necessary, the universal end cap can be shortened on site.

Assembly of end cap with lip labyrinth seal (LLS)

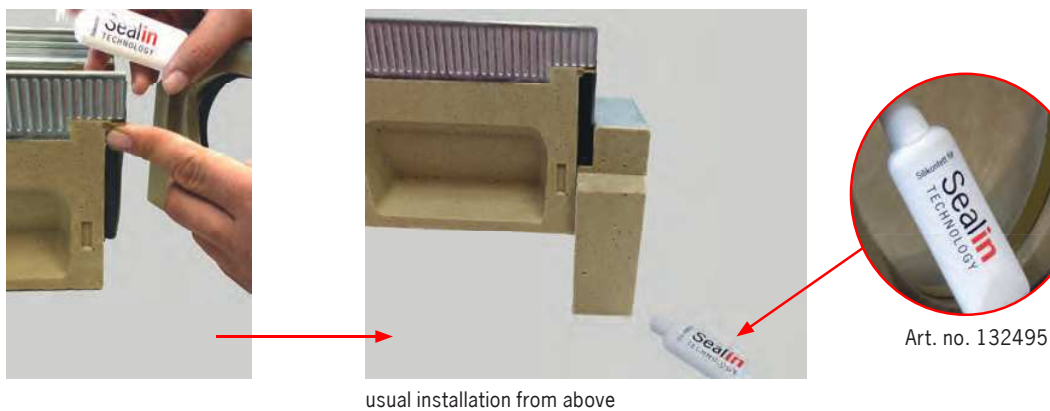

The end cap with lip labyrinth seal is suitable for horizontal, water-tight pipe connection for the channel end.

We recommend using our specially adapted silicone grease to install the channel.

C Fabrication of fitting pieces or adapters to change flow direction

Required tools

- Folding ruler
- Polyester adhesive with hardener (Art. no. 02163)
- Cup wheel for angle grinder
- Diamond cutting disk for angle grinder
- Spatula

Measuring the dimensions

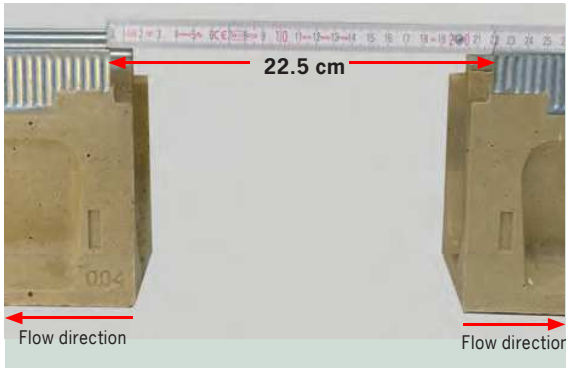

As shown exemplarily in the picture an adapter of 22,5 cm is needed. Following steps describe how to do.

Longitudinal and mitre cuts

Note:

To fabricate other longitudinal and mitre cuts, cut the channel elements, grind and glue the adhesive surfaces according to the procedure described below. It must be ensured that the stop and shift protection of the gratings remain functional.

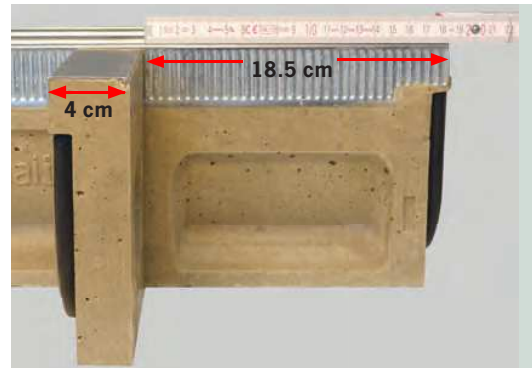

In this example:
 $22.5 \text{ cm} - 4 \text{ cm} = 18.5 \text{ cm}$

Cutting the channel body to length

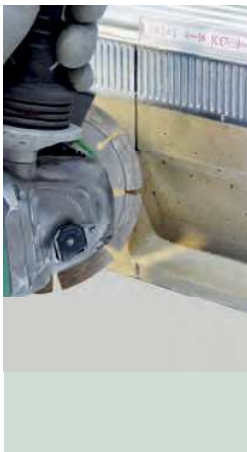

cutting the channel body to size

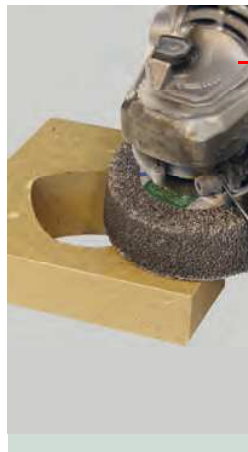

grinding the adhesive surfaces

Please use a diamond cutting disk to cut the channel body to the measured dimension (in this case 18.5 cm). To obtain a grease-free and flat surface, we recommend grinding the adhesive surfaces with a cup wheel for stone.

Gluing and inserting the individual components

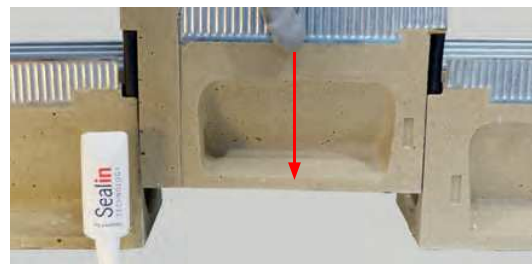

Afterwards, the components can be glued using the polyester adhesive, and pressed together firmly. Excess adhesive can be removed with a spatula. After a few seconds, both components are permanently glued and can be used again.

Now the glued fitting piece can be inserted, as shown in the picture, into the free space from above.

D Fabrication of corner, T or cross connection

Required tools

- Polyester adhesive with hardener (Art. no. 02163)
- Cup wheel for angle grinder
- Drill with masonry bit
- Hammer and chisel
- Spatula



Knocking out the recess



pre-drilling



knocking out the recess

Pre-treating the adhesive surfaces

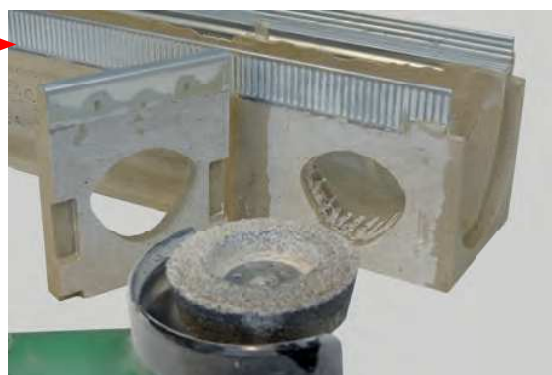

grinding the adhesive surfaces

To create the side opening on the half-metre element, drill along the pre-perforated recess using a drill with a masonry bit (6 mm). Please do not use the hammer drill function. Afterwards, the prepared recess can be knocked out using a hammer and chisel.

To obtain a grease-free and flat surface on the parts to be glued, we recommend pre-treating the adhesive surfaces with a cup wheel for stone.

Gluing the individual components

Note:

When creating a corner connection, make sure that the universal end cap is mounted **before** the components are glued with the polyester adhesive!



Gluing should be performed as follows: mix the polyester adhesive with the correct mixing ratio of the hardener, apply it to the adhesive surfaces, and finally glue both parts together (see enclosed instructions).

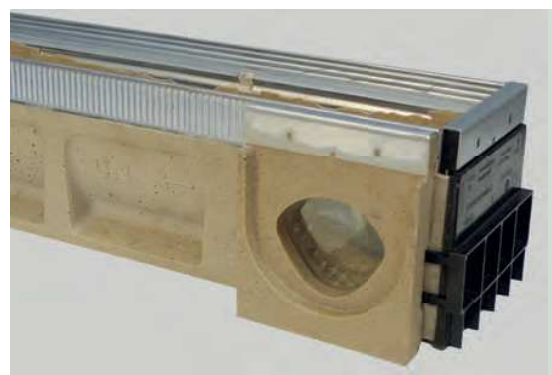

After the polyester adhesive has hardened, the channel elements can be inserted from above as usual.

E Installation of channel and Installation drawings for plaster, asphalt and concrete

Installing the channel

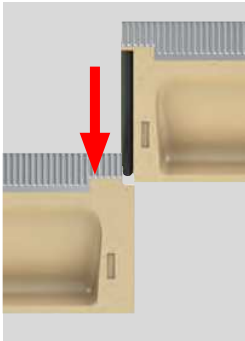

The straightforward, tried-and-tested method of installation shown above is also used in the new Multiline Sealin.

As before, it is fundamentally based on installing the channel without any gaps on a compacted channel foundation (please have a look at detailed installation advices in this guideline), **taking into account the moulded arrow direction on the channel body** and **the sequence of channel types in the case of sloping channels.**

Installation must always begin at the lowest point; i.e. at the transition point where the watercourse begins (e.g. the pipe system or the catch basin).



Silicone grease for seal

The new EPDM seal, integrated as standard, requires the use of a commercial lubricant. To ensure the seal has maximum effect, we recommend using AC0 silicone grease (art. no. 132495), which is specifically designed to meet the requirements of Sealin technology.

Installation in paved areas, load class A15 to C250

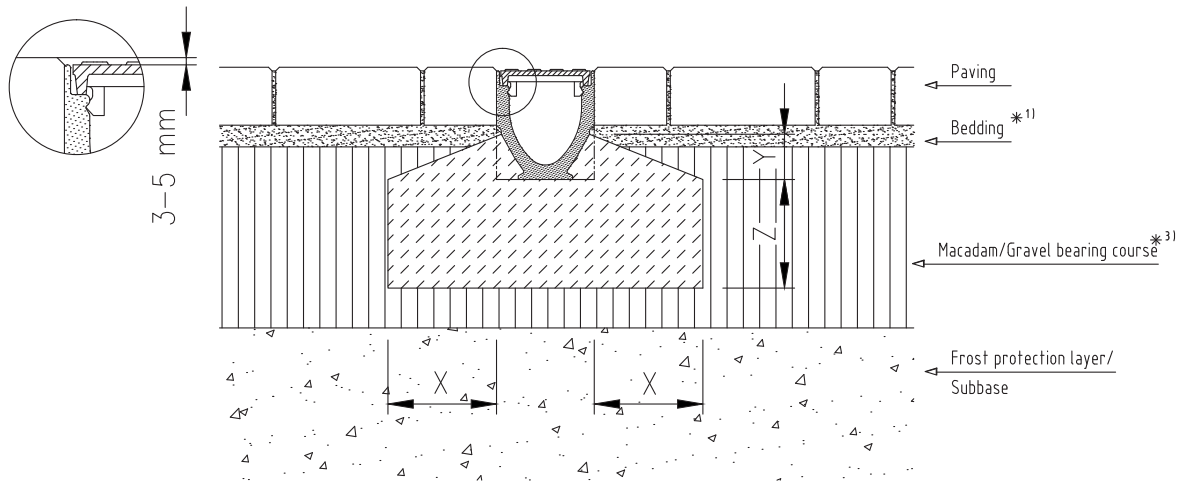

Not for lateral crossing on high frequent roads, in housing estates or in front of railway crossings!

Load Class	(ref. DIN EN 1433)	A 15	B 125	C 250	D 400	E 600	F 900
Min. Quality for Bedding Concrete	(ref. DIN EN 206-1)	≥ C 12/15	≥ C 12/15	≥ C 12/25			
Exposure class *16)		(X0)	(X0)	(X0)			
Bedding Dimensions	X	≥ 10	≥ 10	≥ 15			
	Y	≥ 7	≥ 7	≥ 7			
	Z	≥ 10	≥ 10	≥ 15			

*...) please see list of footnotes at beginning of chapter drawings

Installation in paved areas, load class D400

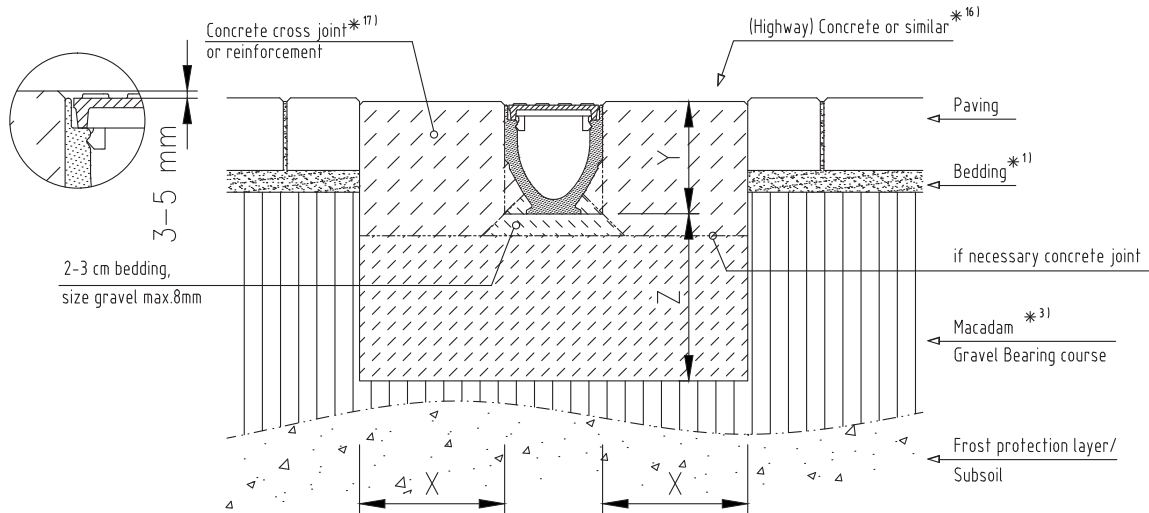

Not for lateral crossing on high frequent roads, in housing estates or in front of railway crossings!

Load Class	(ref. DIN EN 1433)	A 15	B 125	C 250	D 400	E 600	F 900
Min. Quality for Bedding Concrete	(ref. DIN EN 206-1)				≥ C 25/30	project specific	
Exposure class *16)					(X0)	enquiry	
Bedding Dimensions	X				≥ 20		
	Y				Height of Channel		
	Z				≥ 20		

*...) please see list of footnotes at beginning of chapter drawings

Installation in asphalted areas, load class A15 to C250

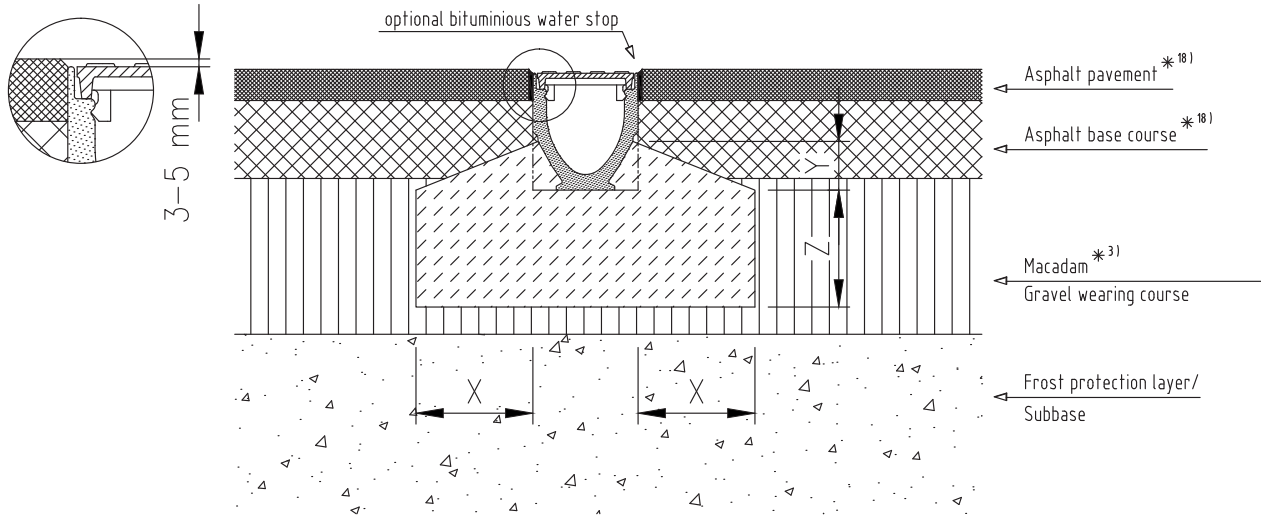

Not for lateral crossing on high frequent roads, in housing estates or in front of railway crossings!

Load Class	(ref. DIN EN 1433)	A 15	B 125	C 250	D 400	E 600	F 900
Min. Quality for Bedding Concrete	(ref. DIN EN 206-1)	≥ C 12/15	≥ C 12/15	≥ C 12/25			
Exposure class *16)		(X0)	(X0)	(X0)			
Bedding Dimensions	X	≥ 10	≥ 10	≥ 15			
	Y	≥ 7	≥ 7	≥ 7			
	Z	≥ 10	≥ 10	≥ 15			

*...) please see list of footnotes at beginning of chapter drawings

Installation in asphalted areas, load class D400 For heavy duty load please see footnote *7)

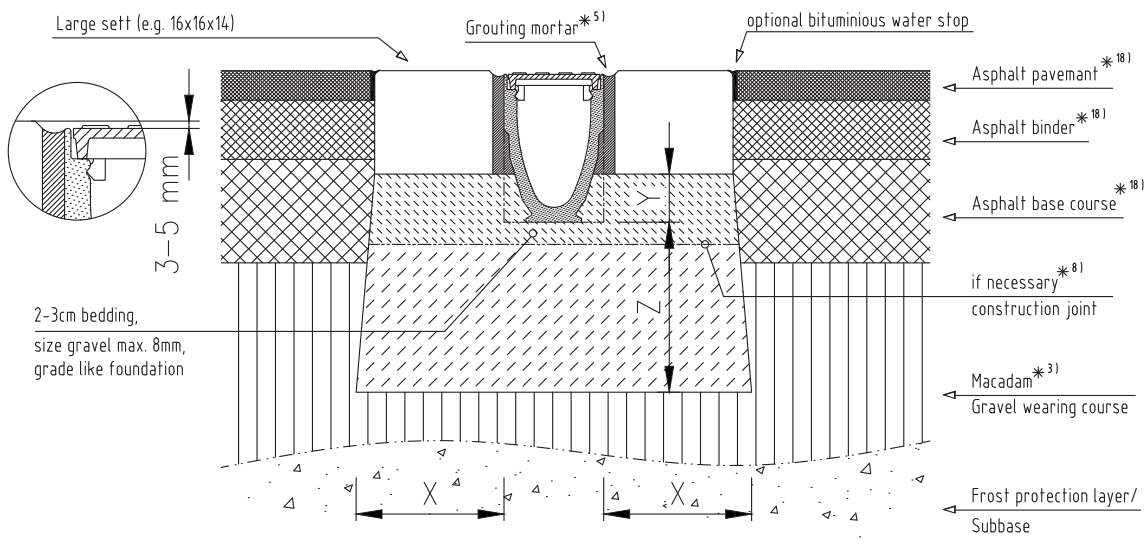

Not for lateral crossing on high frequent roads, in housing estates or in front of railway crossings!

Load Class	(ref. DIN EN 1433)	A 15	B 125	C 250	D 400	E 600	F 900
Min. Quality for Bedding Concrete	(ref. DIN EN 206-1)				≥ C 25/30	project specific	
Exposure class *16)					(X0)	enquiry	
Bedding Dimensions	X				≥ 20 (25)		
	Y				Bottom of large sett		
	Z				≥ 20 (25)		

*...) please see list of footnotes at beginning of chapter drawings

Installation in asphalted areas, load class D400

For heavy duty load please see footnote *7)

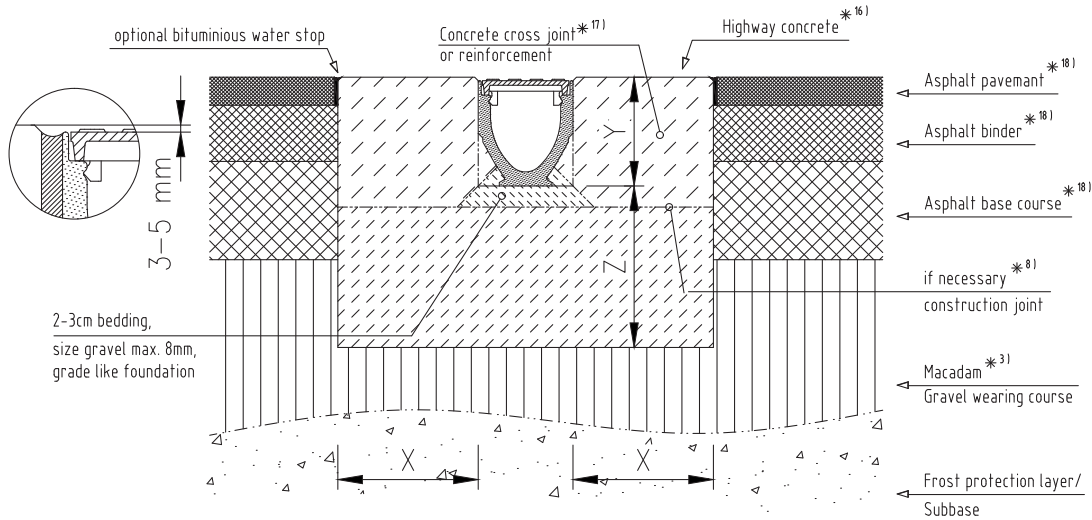

Not for lateral crossing on high frequent roads, in housing estates or in front of railway crossings!

Load Class	(ref. DIN EN 1433)	A 15	B 125	C 250	D 400	E 600	F 900
Min. Quality for Bedding Concrete	(ref. DIN EN 206-1)				≥ C 25/30	project specific	
Exposure class *16)					(X0)	enquiry	
Bedding Dimensions	X				≥ 20 (25)		
	Y				Height of channel		
	Z				≥ 20 (25)		

*...) please see list of footnotes at beginning of chapter drawings

Installation in asphalted areas, load class D400

For heavy duty load please see footnote *7)

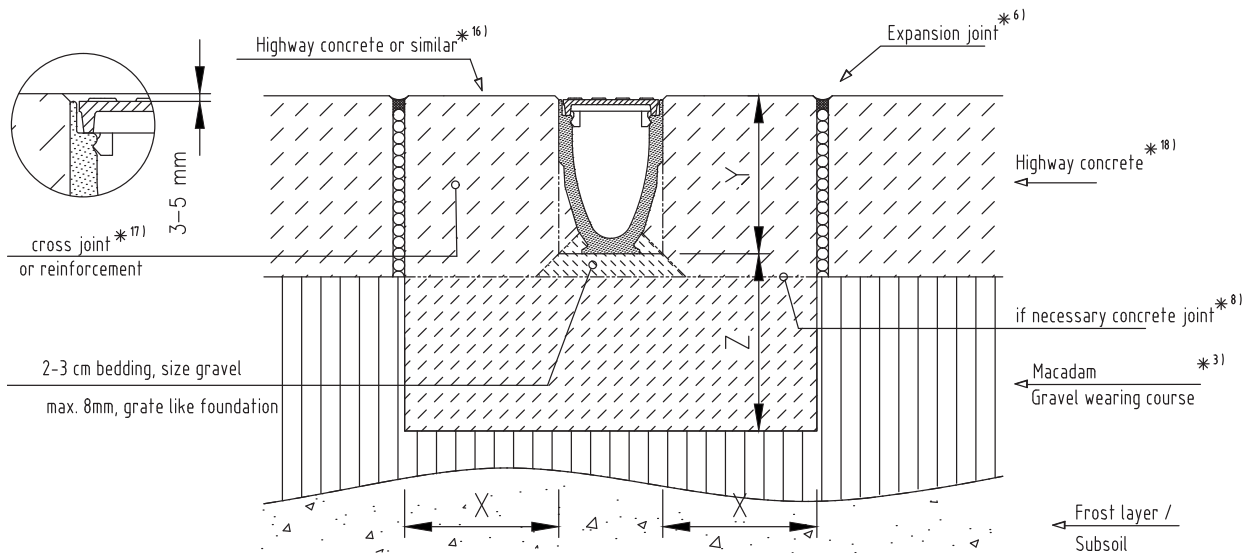

Not for lateral crossing on high frequent roads, in housing estates or in front of railway crossings!

Load Class	(ref. DIN EN 1433)	A 15	B 125	C 250	D 400	E 600	F 900
Min. Quality for Bedding Concrete	(ref. DIN EN 206-1)	≥ C 12/15	≥ C 12/15	≥ C 12/25	≥ C 25/30	project specific	
Exposure class *16)		(X0)	(X0)	(X0)	(X0)	enquiry	
Bedding Dimensions	X	≥ 10	≥ 15	≥ 15	≥ 20		
	Y	Height of channel					
	Z	≥ 10	≥ 10	≥ 15	≥ 20		

*...) please see list of footnotes at beginning of chapter drawings

Installation in paved areas, load class A15 to C250

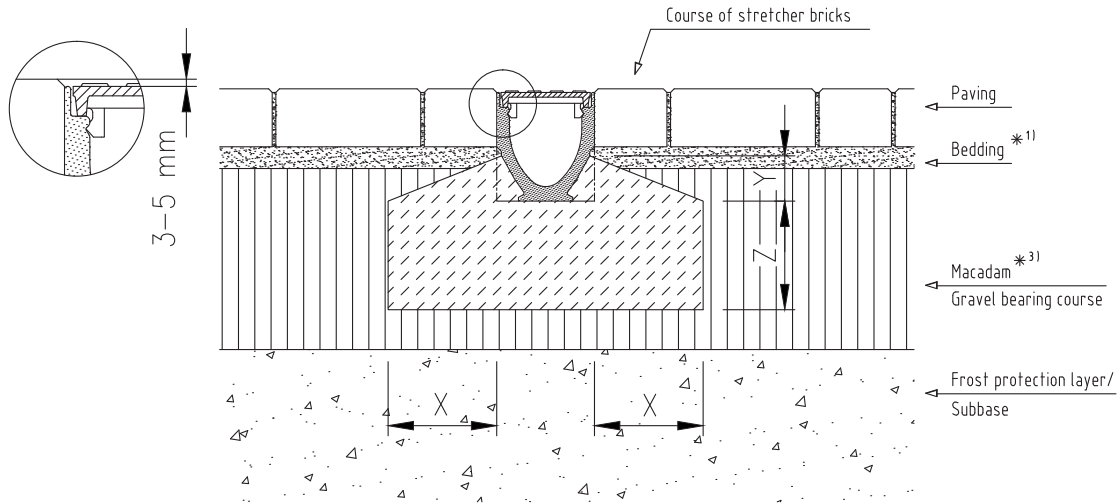

Not for lateral crossing on high frequent roads, in housing estates or in front of railway crossings!

Load Class	(ref. DIN EN 1433)	A 15	B 125	C 250	D 400	E 600	F 900
Min. Quality for Bedding Concrete	(ref. DIN EN 206-1)	≥ C 12/15	≥ C 12/15	≥ C 20/25			
Exposure class *16)		(X0)	(X0)	(X0)			
Bedding Dimensions	X	≥ 10	≥ 10	≥ 15			
	Y	Height of Edge Pocket *2)					
	Z	≥ 10	≥ 10	≥ 15			

* ...) please see list of footnotes at beginning of chapter drawings

Installation in paved areas, load class D400 For heavy duty load please see footnote *7)

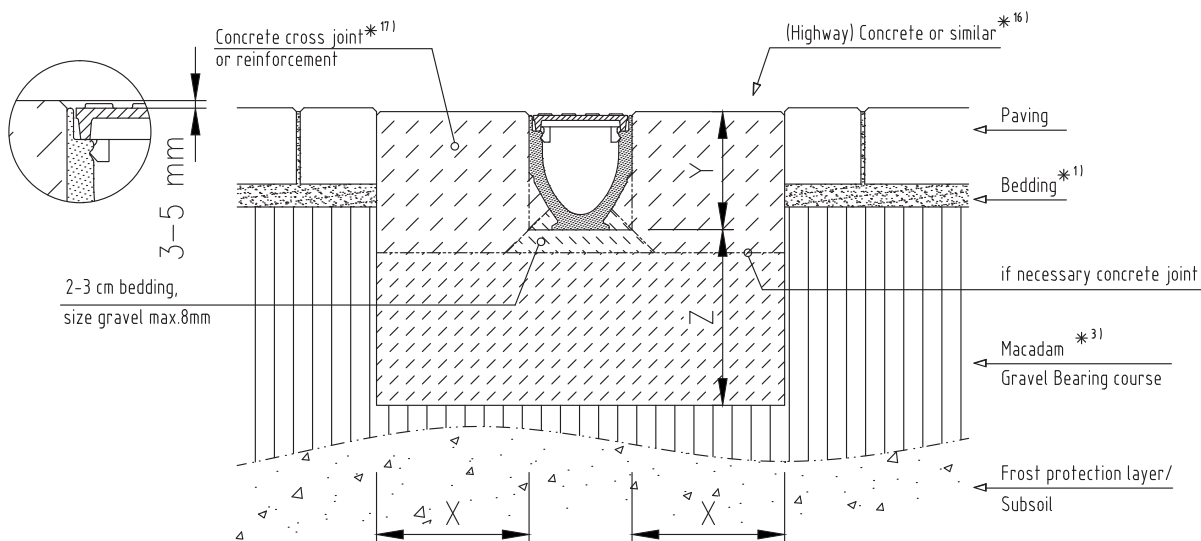

Not for lateral crossing on high frequent roads, in housing estates or in front of railway crossings!

Load Class	(ref. DIN EN 1433)	A 15	B 125	C 250	D 400	E 600	F 900
Min. Quality for Bedding Concrete	(ref. DIN EN 206-1)				≥ C 25/30	project specific	
Exposure class *16)					(X0)	enquiry	
Bedding Dimensions	X				≥ 20 (25)*4)		
	Y				Height of Channel		
	Z				≥ 20 (25)*4)		

* ...) please see list of footnotes at beginning of chapter drawings