

Joints

Construction and sealing of joints according to valid standards and regulations. Therefore an appropriate joint plan has to be provided by the planner.

Expansion joints may not be installed directly to the channel, because the channel cannot take the loadings from thermal caused concrete expansion.

Longitudinal expansion joints are recommended to be positioned according to the appropriate ACO Drain installation advice.

If transversal joints cross the channels bed and haunch, such joints may be positioned to coincide with the channel-to-channel joint, or the channel may be cut to suit and re-sealed with suitable flexible sealant.

At afterwards installation of channels in concrete or pavement in concrete bedding the planner has to make sure, that enough expansion joints will be installed. The joints have to ensure,

that thermal expansions from the concrete slab won't harm the channel.

In an unreinforced concrete haunch please position a concrete joint every 1-2 m. Alternatively the haunch could be constructed reinforced.

Longitudinal expansion joints may be doweled if necessary.

At use of mastic asphalt we recommend filling the joint in two phases. First fill grouting mortar up to 1,5 cm under surface level and second fill remaining space with bituminous water stop.

The final location, width and geometry of expansion joints have to be determined by the planner or structural engineer.

Sealing

According to EN 1433 the body of drainage channels has to be watertight and the design has to provide a possibility of sealing the channel joints.

With the patented safety joint ACO provides a well-fitting channel joint which can be sealed to get a watertight channel up to the top of the edge rail, if required.

The preinstalled lip labyrinth sealing makes a watertight connection of vertical pipes possible.

For an elastic sealing we recommend to use EUROLASTIC TC 30S as sealant in conjunction with EUROLASTIC Primer S2, or similar, depending on what's available on your market. Please contact your local supplier to get more information about appropriate products.

1. Seek the sealant manufacturer's advice on suitability on all occasions.
2. For filling the sealant into the groove please use the sealing set (art.no. 01376) consisting of a cartridge gun, a cartridge, a stirrer and some tips in different sizes.
3. Storage of the sealant has to be frost free.
4. Use of the sealant at minimum 5°C (41°F) air temperature and surface temperature of 5 – 35°C (41-95°F). At 20°C (68°F) the curing time is 24 hours.
5. Attention: Polymer concrete surfaces have to be cleaned carefully.
6. After cleaning put on primer EUROLASTIC Primer S2 (art.no. 10682) by using a paintbrush and let it flash off for approx. 30 minutes.
7. Put the cartridge with the 2 component sealant into the cartridge holder and stir it by using the stirrer with a drilling machine. Mix the sealant at least 3 minutes with 400 turns per minute until the colour is unique.
8. Before setting cartridge into the cartridge gun, please remove the plastic cap, which is only needed for the use of sealant in bags.
9. Always make sure, that the sealant is connected to the sealing at the channel edge to ensure a complete sealed system.
10. Smooth the surface by using a spatula which is dipped in soap solution.
11. Cleaning of equipment with acetone or Eurolastic G.
12. Technical data and safety sheets are available at www.euroteam-bauchemie.de or at the international support department at ACO headquarter in Büdelsdorf.

ACO polymer concrete and the sealant are resistant against a wide range of mediums. For information about all not listed mediums, please contact the ACO International Support Department.

If Multiline Seal in or Monoblock RD200V is used, a sealing of joints is not necessary, because these systems have an integrated sealing.

Channel systems made of plastic require an additional effort if joints have to be sealed. XtraDrain and Hexaline are made of Polypropylene and have to be welded to get watertight joints.

Special installation advices

All shown installation details are exemplary advices and represent the whole channel system. Even the illustration of paving and asphalt layer is representative and has to be adjusted to the planner's advice and all valid local regulations and standards.

According EN 1433 ACO channels may have tolerances in height, length and width of ± 2 mm. Additional tolerances during installation are possible and have to be considered.

Depending on the circumstances and the local requirements drainage channels always need a foundation (Type M) like shown in our ACO DRAIN® installation advice.

Where a channel drain is being inserted within an existing slab, in a box-out cut or cast within a slab, a minimum 25 mm clearance around the channel is required for grouting. The channel may be suspended in the box-out while being grouted. Bed and haunch the channel with a proprietary epoxy-mortar grout with a minimum strength of 30N/mm²; advice should be sought from the grout manufacturer.

If a channel crosses an expansion joint in an existing concrete slab, the channel should be sawn in half where it crosses the joint, and re-joined with a proprietary flexible sealant.

Shallow channels are special channels which only differ in height from ordinary channels. Caused by the shallow clear height the hydraulic capacity is limited and should be proved by an ACO application engineer. In general they are used in parking decks, inside buildings or in areas with shallow layers and limited space.

Drainage channels in floors should always be installed upon the waterproofed layer. A direct connection of waterproofed layer and channel is not possible. Sealing of the channel joints is highly recommended.

When intermediate piece DN100 or DN150 with clamping flange is used, the nozzle may not reach longer than 60mm into the intermediate piece to provide a proper runoff of the water.

Drainage channels are always installed on same level like the adjusting area. In asphalt or paved areas the channel top shall be installed app. 5mm under the surrounding surface. In concrete areas a levelled installation is possible.

In areas with more than 5 % slope we recommend to choose one load class higher than needed to make sure, that thrust and other loadings are distributed properly.

At extreme loadings within load class D400 – F900 you should differ between occasionally and constantly traffic.

Even traffic crossing the channel, narrow corners, slow moving traffic, often braking and accelerating could mean to install after a special installation advice.

In case of extreme loadings we recommend to install according one load class higher than needed.

Extreme loadings could be container terminals, loading zones, logistic areas or sloped areas.

For these application we advise to choose ACO DRAIN® PowerDrain or ACO DRAIN Monoblock system.

In front of rail way crossings we recommend to use Monoblock in every case.

As well for high dynamic loaded areas like highways we recommend using Monoblock only.

Accessories like sump units and revision units should always be located outside the trafficked area.

Mitre joints are formed by sawing the channels (eg with disc cutter) to the required angle and butting them together dry jointed or resin bonded. A suitable adhesive should be used in a corrosive environment. The sealant used should be able to withstand contact with the effluent or chemical solution.

Where possible, 90° joints and Ts should be formed such that gratings do not have to be cut. 90° channel junctions are available as standard and pre-mitred joints are available to special order, or angles can be formed with connecting proprietary PVC pipework on ACO inlet/outlet endcaps.

Note: For load classes higher than C250, mitred joints are not recommended in trafficked areas and it is recommended that ACO DRAIN® S Range and PowerDrain are not mitred. ACO can custom-manufacture angled junctions to order. Always consider health and safety instructions when cutting.

Special installation advices



Products made from galvanized steel should only be installed in areas where contact to chemical cleaning devices, heavy acids and solutions as well as acetic acid containing silicon is impossible. For special applications please get in contact with an ACO application engineer.

During installation and site work products made from stainless steel should be protected against flying sparks (Disc cutter) and flash rust during installation to prevent a bad looking surface and a dissatisfied customer. We recommend testing the compatibility of stainless steel (1.4301) and other metals to avoid contact corrosion. For applications with contact with sea air, salt water, chemicals or other environmental influences please check if more high-grade stainless steel would be better to use. To keep the good looking smooth surface of stainless steel products and to prevent rusting we recommend to clean all surfaces occasionally with fresh water.

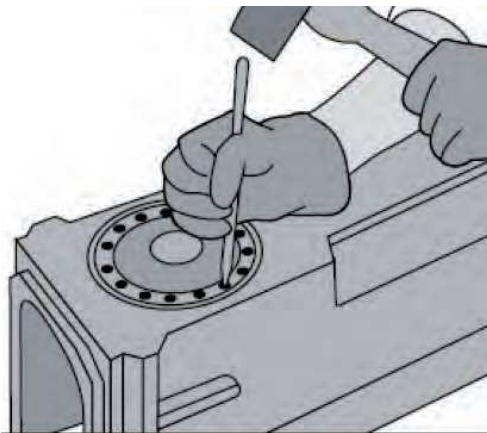

Please cut black rubber walls at sump units not before cleaning the channel and the silt bucket to prevent dirt entering the sewage system before customer has made the approval of the project. For cutting please use a sharp knife and cut along the connected channel.

At Brickslot frames in brick paved areas it might happen, that sand from transversal paving joints trickles into the slot.

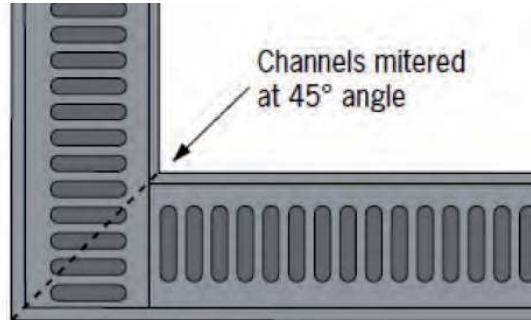

**Channels are mitered;
grates are shown as tee joint.**

Products made from ductile iron are delivered with two different coatings. ACO DRAIN® PowerDrain is coated with a cathodic dip painting, which is quite long lasting dependent on the environmental influences.

All other systems are delivered with a coating which is meant to be a temporary protection for storing, delivery and installation and will be removed after short time to give the grating and edge rail the typical ductile iron look. This is no lack of quality and no reason for a complaint at all.

All preformed knockouts are made to be knocked out from the inside to the outside. To avoid breakage we highly recommend perforating the knockout by drill or chisel before knocking out.

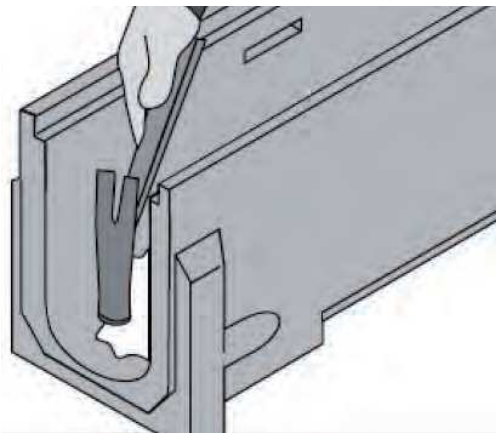

At Brickslot frames in asphalt areas we recommend installing a row of bricks adjoining the slot frame to make the installation of the asphalt easier. Even a possible renewing of the surface is much easier if the cold planer can use the row of bricks as a fence.

To protect the environment we recommend sealing joints in areas where will be handled with hazardous liquids and

and mediums. Before sealing please make sure that all materials and mediums are compatible to each other. If you have doubts, please contact ACO International Support Department to get the remaining information.

For this kind of applications, it might be necessary to have a closer look for some special regulations in your state or county.

Grouting of joints between kerbs and channel or facades and channel should be made like shown in the appropriate ACO DRAIN® installation advice later on in this guideline. We recommend using a high-strength (but dynamic loadable), non-shrinking and de-icing salt resistant mortar which meets all requirements considering all conditions (loading, resistance etc.) on site. The joints measurements shall be according to the mortar manufacturers advice.

To prevent mortar leaking into the channel we recommend to tighten channel joints from the outside (duct tape) before grouting.

Materials of manufacture

ACO drain channels are manufactured from ACO resin concrete, consisting of polyester resin reinforced by mineral aggregates and fillers or.

The appearance is self-coloured light brown or can be pigmented to match virtually any colour shade, and resin concrete offers high quality, precise detailing.

A channel repair kit comprising polyester paste and hardeners is available for minor repairs or non-flexible channel joints.

Physical properties

Channels

ACO resin concrete is a strong material offering approximately four times the compressive strength of average concrete, and half the weight (for an equivalent channel section).

ACO drain systems are available in types to suit load classes A15 to F900 as specified in EN 1433.

Flexural strength	20 - 25 N/mm ²
Compressive strength	90 - 100 N/mm ²
Modulus of elasticity	20 - 25 N/mm ²
Density	2,1 - 2,3 g/cm ³
Typical water absorption	0,05 - 0,1 % (by weight)
Roughness	25 µm
Fire behaviour	non-flammable
Water penetration	0,0 mm

When connecting the pipe to the sump unit, please don't push the pipe against the silt bucket.

To get the optimum outlet capacity the pipe has to be inserted only right through the lip labyrinth sealing.

If foul air traps are used, please consider that water remaining in the sump unit could freeze in winter times and cause distortion of the sump unit.

Sump units shall be installed appropriate to the channel system.

For special demands or custom made products which you won't find in this guideline please feel free to get in contact with the ACO International Technical Support Team, who will help you creating a proper solution for your special application.



Comparison of drainage channel materials

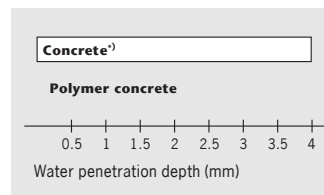

Water penetration depth (DIN 4281) after 72 hours

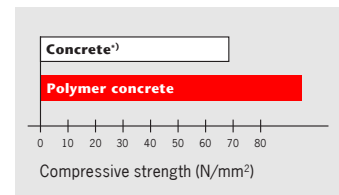

Compressive strengths

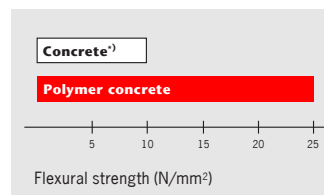

Flexural strengths

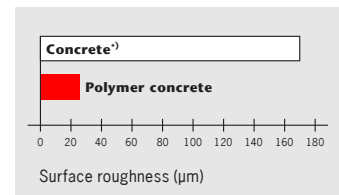

Average surface roughness of drainage channels

¹⁾ Concrete for use according to DIN EN 1433

Surface performance

The ultra-smooth internal surface (Manning Strickler roughness coefficient average value is 0,011) encourages superior liquid flow for a given nominal cross-section when compared to conventional concrete. ACO drain channels allow greater discharge rates to be achieved, or longer lengths of channel to be installed before an outlet from the system is required.

Chemical resistance

Standard polyester resin concrete ACO drain channels are highly resistant to chemical attack and, with the appropriate grating, can be used in most environments where acids and dilute alkalis are likely to be encountered. The material is not affected by road de-icing salts.

In situations where exposure to aggressive chemicals is likely please check resistance of polyester resin concrete. See chart on page 20, which gives the resistance of standard polyester and joint sealant to various common industrial and agricultural chemicals with given concentration at room temperature (23°C).

Reaction to fire

For applications in tunnels it is very important to provide a non-flammable channel unit. Our special mixture of polyester resin concrete fulfils this requirement and is tested according EN 13501-1.

Gratings

Separate gratings are available in galvanised steel, stainless steel, epoxy glass reinforced composite and ductile iron. Special grating materials and non-standard finishes are available on request.

Grating bolts, where provided, are Tuflok coated high-tensile steel or stainless steel with integral friction grip washers. Quicklock and Powerlock are provided as standard locking on some systems.

Resistance to high and low temperatures

With low moisture absorption the channels are completely resistant to frost. The maximum temperature for permanent content is 80°C.

ACO drain channels can be occasionally exposed to boiling water, or steam cleaned, without risk of damage. Where continual exposure to boiling liquids or intensive steam cleaning is likely, an alternative channel material, for example stainless steel, should be considered; contact Inotec Sportanlagen- und Edelstahltechnik GmbH on +49-(0)4331-354-600

Resistance to vandalism

Most ACO drain systems are available with lockable gratings which are sufficient to deter casual vandalism. Where vandalism is likely to be a serious problem, bolted gratings should be specified or alternatively a security locking can be used to prevent vandalism.



Installation at roadside, load class C250 to D400

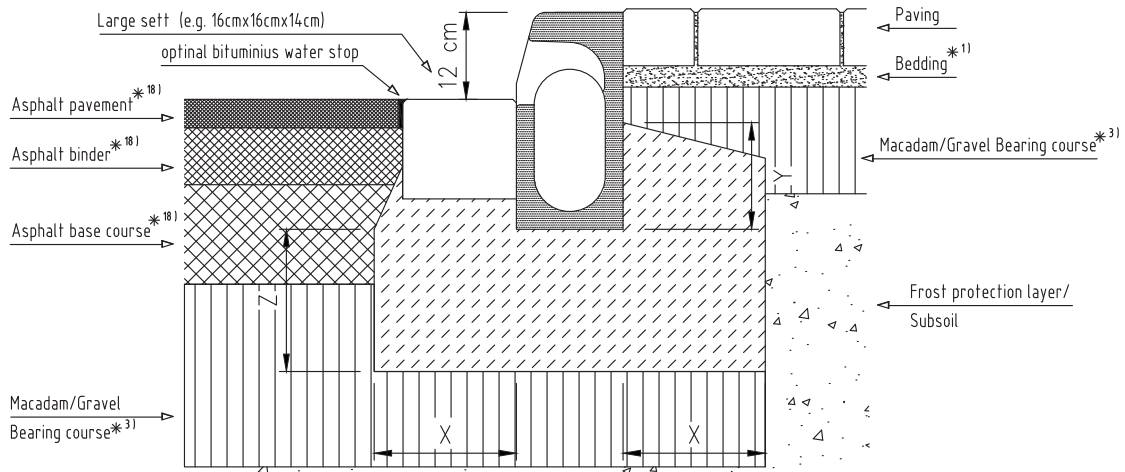

Not for lateral crossing on high frequent roads, in housing estates or in front of railway crossings!

Load Class	(ref. DIN EN 1433)	A 15	B 125	C 250	D 400	E 600	F 900
Min. Quality for Bedding Concrete	(ref. DIN 1045-2)			C 20/25	C 20/25		
Exposure class *16)				(X0)	(X0)		
Bedding Dimensions (ref. DIN EN 1433)	X			≥ 15	≥ 20		
	Y for KD 305			≥ 18	≥ 18		
	Y for KD 480			≥ 36	≥ 36		
	Z			≥ 15	≥ 20		

*...) please see list of footnotes at beginning of chapter drawings

Installation at roadside, load class C250 to D400

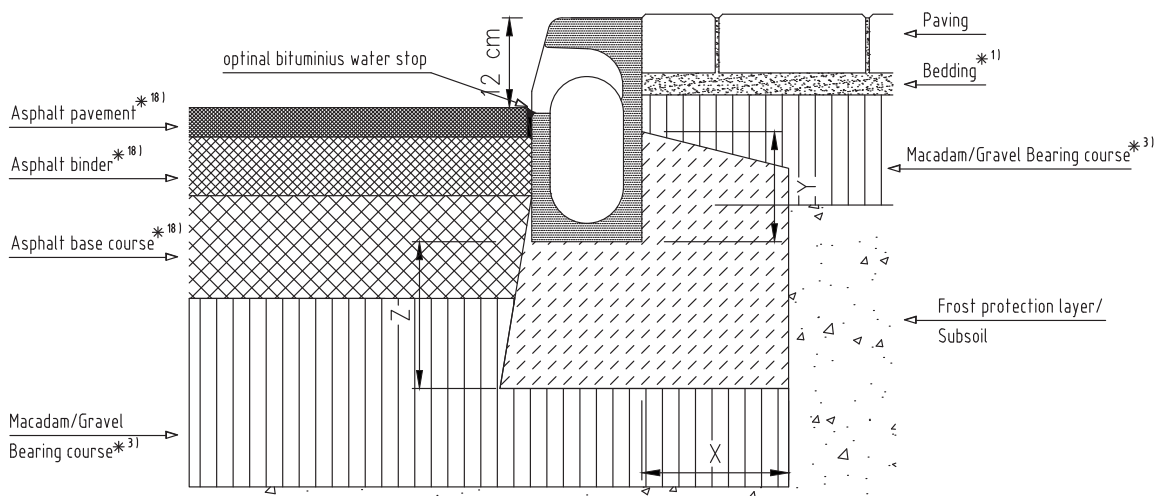

Not for lateral crossing on high frequent roads, in housing estates or in front of railway crossings!

Load Class	(ref. DIN EN 1433)	A 15	B 125	C 250	D 400	E 600	F 900
Min. Quality for Bedding Concrete	(ref. DIN 1045-2)			C 20/25	C 20/25		
Exposure class *16)				(X0)	(X0)		
Bedding Dimensions (ref. DIN EN 1433)	X			≥ 15	≥ 20		
	Y for KD 305			≥ 18	≥ 18		
	Y for KD 480			≥ 36	≥ 36		
	Z			≥ 15	≥ 20		

*...) please see list of footnotes at beginning of chapter drawings